



AGM Battery series

Datasheet : 6FM1.2(12V1.2AH)

Nominal Voltage	12V
Number of cell	6
Design Life	5 years
Nominal Capacity 77°F(25°C)	
20 hour rate (0.06A, 10.5V)	1.2Ah
10 hour rate (0.117A, 10.5V)	1.17Ah
5 hour rate (0.23A, 10.5V)	1.15Ah
1 hour rate (0.89A, 9.6V)	0.89Ah
Internal Resistance	
Fully Charged battery 77°F(25°C)	≤88mOhms
Self-Discharge	
3% of capacity declined per month at 20°C(average)	
Operating Temperature Range	
Discharge	-20~60°C
Charge	-10~60°C
Storage	-20~60°C
Max. Discharge Current 77°F(25°C)	18A(5s)
Short Circuit Current	60A
Charge Methods: Constant Voltage Charge 77°F(25°C)	
Cycle use	2.30-2.35VPC
Maximum charging current	0.48A
Temperature compensation	-30mV/°C
Standby use	2.23-2.27VPC
Temperature compensation	-20mV/°C



Wide Range Temperature	Warranty	Maintenance Free
AGM Technology	easy use	long life

Mechanical Characteristics

Length(mm / inch)	97 / 3.82
Width(mm / inch)	43 / 1.69
Height(mm / inch)	52 / 2.05
Total Height(mm / inch)	58 / 2.28
Approx. Weight(Kg / lbs)	0.51 / 1.12
* Weight deviation: ± 5%	

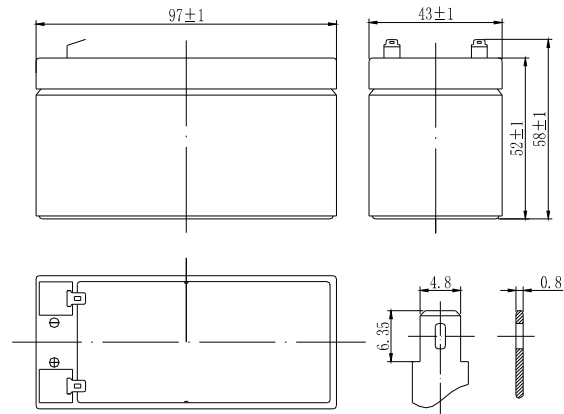

Technical Characteristics

Discharge Constant Current (Amperes at 77°F25°C)

End Point	Volts/Cell	5min	10min	15min	30min	1h	3h	5h	10h	20h
1.60V	5.72	3.85	2.67	1.49	0.89	0.39	0.25	0.129	0.065	
1.65V	5.42	3.66	2.55	1.43	0.86	0.37	0.24	0.125	0.064	
1.70V	5.12	3.48	2.43	1.36	0.83	0.36	0.24	0.120	0.064	
1.75V	4.80	3.28	2.31	1.30	0.79	0.34	0.23	0.117	0.060	
1.80V	4.48	3.08	2.18	1.23	0.76	0.33	0.22	0.115	0.060	

Discharge Constant Power (Watts at 77°F25°C)

End Point	Volts/Cell	5min	10min	15min	30min	45min	1h	2h	3h	5h
1.60V	9.90	6.24	5.14	2.94	1.79	0.73	0.50	0.257	0.130	
1.65V	9.28	5.87	4.85	2.78	1.72	0.72	0.49	0.253	0.127	
1.70V	8.67	5.51	4.58	2.64	1.64	0.69	0.48	0.249	0.124	
1.75V	8.06	5.15	4.29	2.49	1.56	0.67	0.47	0.245	0.121	
1.80V	7.47	4.79	4.00	2.33	1.47	0.66	0.46	0.240	0.113	

(Note)The above characteristics data are average values obtained within three charge/discharge cycles. All data shall be changed without notice, Neata reserves the right to explain and update the information.



AGM Battery series

Datasheet : 6FM1.2(12V1.2AH)

Discharge Characteristics Curve

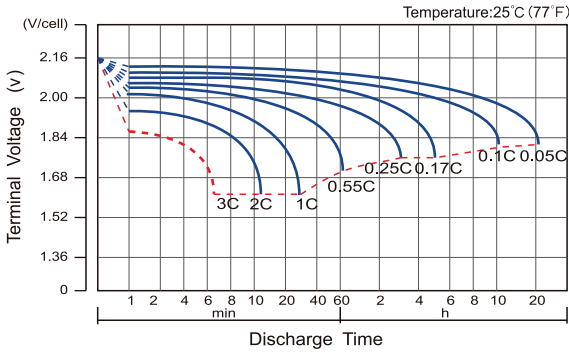

Charge Characteristic Curve For Standby Use

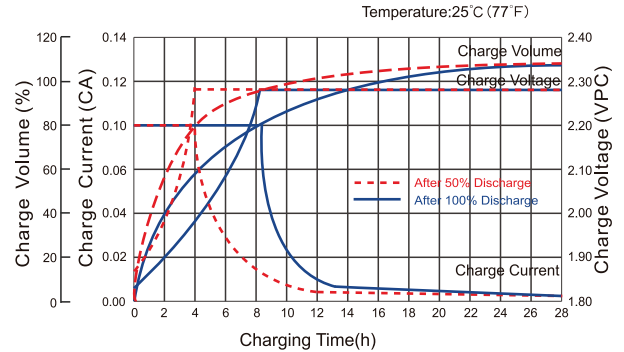

Cycle Life In Relation To Depth Of Discharge

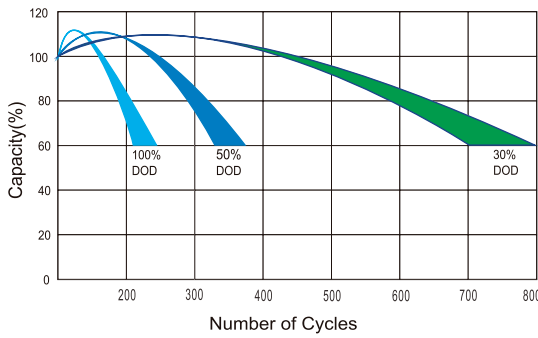

Temperature Effects On Capacity

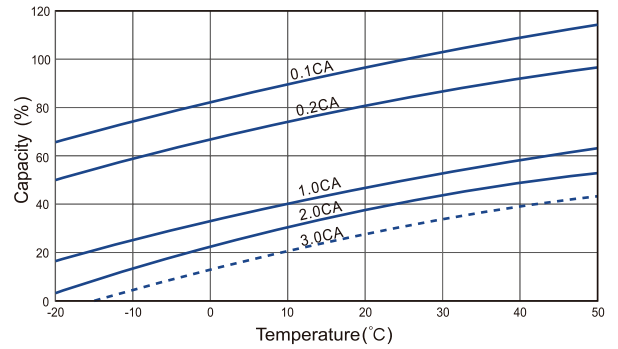

Relationship Between Charging Voltage And Temperature

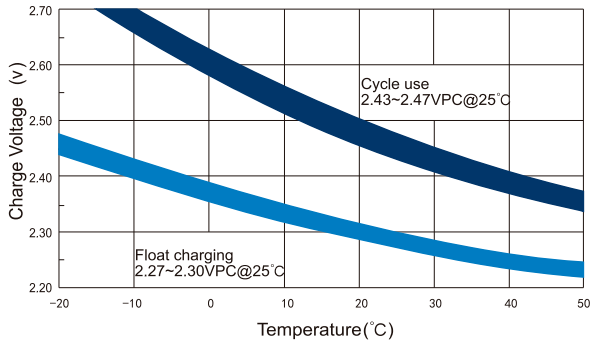

Storage Characteristics

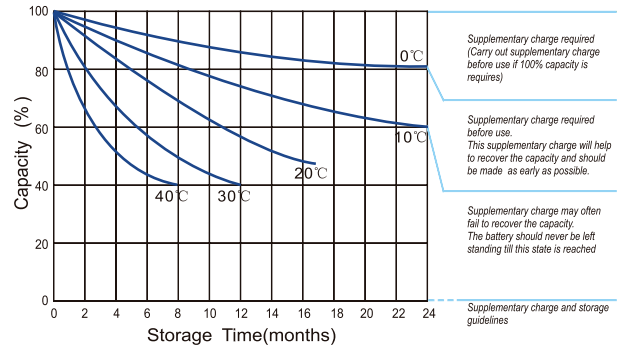

Effect Of Temperature On Long Term Life

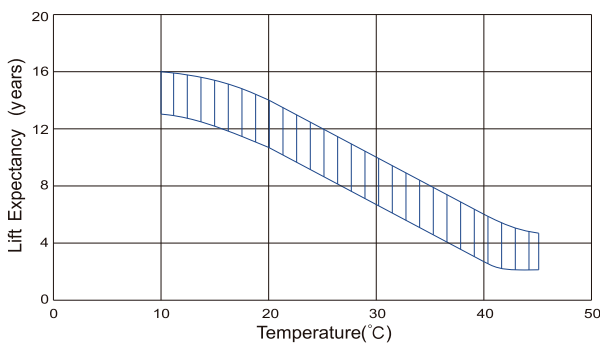

Life Characteristics Of Standby Use

